

5.94-Tb/s 1.49-b/s/Hz ($40 \times 2 \times 2 \times 40$ Gb/s) RZ-DQPSK Polarization-Division Multiplex *C*-Band Transmission Over 324 km

Suhas Bhandare, David Sandel, Biljana Milivojevic, Ariya Hidayat, Abas Ahmad Fauzi, Hongbin Zhang, Selwan K. Ibrahim, Frank Wüst, and Reinhold Noé, *Member, IEEE*

Abstract—The combination of return-to-zero differential quadrature phase-shift keying with polarization-division multiplex, a 16-ary modulation scheme, allows for ultimate spectral efficiency. We raise *C*-band fiber capacity with phase-shift keying transmission beyond previously reported figures, achieving forward-error correction limit performance over four fiber spans.

Index Terms—Differential phase-shift keying (DPSK), polarization, quadrature phase-shift keying, wavelength-division multiplexing (WDM).

I. INTRODUCTION

OPTICAL code-division multiplex combined with wavelength-division-multiplexing (WDM) channel polarization alternation allows for a 1.6-b/s/Hz transmission [1] throughout the whole *C*-band. Other spectrally efficient modulation formats are more chromatic dispersion and polarization-mode dispersion (PMD) tolerant and support larger amplifier spacings. Differential quadrature phase-shift keying (DQPSK) transmission [2], [3] can quadruple fiber capacity if it is combined with polarization-division multiplex [4]–[6] or alternating polarizations [7], [8]. An important concern is nonlinear phase noise at high symbol rates [9] but the existence of forward-error correction (FEC) makes higher raw bit-error rates (BERs) and, hence, larger amounts of phase noise tolerable.

Here we increase the *C*-band capacity beyond the 5.12-Tb/s figure [8] which has recently been reported for DQPSK transmission with alternating polarizations. Return-to-zero (RZ)-DQPSK with polarization-division multiplex is chosen because it bears the potential for even a further capacity increase by reducing the channel spacing below 100 GHz, as has been shown for prefiltered, single-polarization, copolarized RZ-DQPSK [10].

II. TRANSMISSION SYSTEM

Fig. 1 shows the RZ-DQPSK polarization-division multiplex setup for $2 \times 2 \times 40$ Gb/s transmission per WDM channel, similar to [6]. $2^7 - 1$ pseudorandom binary sequence (PRBS) data at 40 Gb/s is obtained from a 16:1 multiplexer that

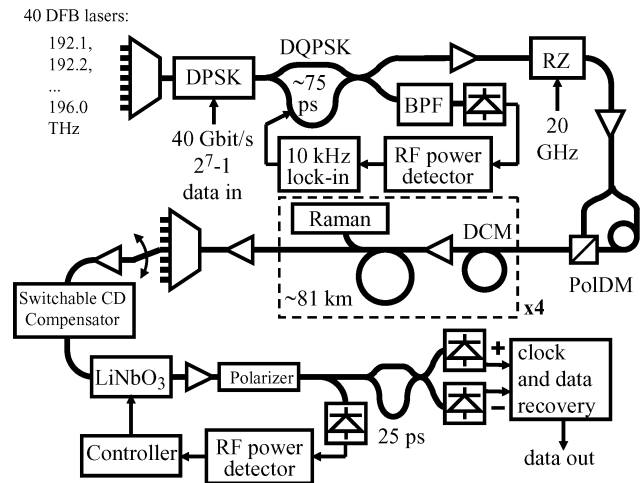

Fig. 1. $40 \times 2 \times 2 \times 40$ Gb/s RZ-DQPSK polarization-division multiplex transmission setup.

combines 16 2.5-Gb/s subchannels mutually delayed by multiples of 8 bits. The PRBS length is limited by intersymbol interference (ISI) in the electrical multiplexer, an effect which introduces penalties and BER floors also in amplitude shift keying transmission. The data is impressed onto 40 WDM channels (192.1, ..., 196.0 THz) with about 100-GHz channel spacing. They are combined with equal polarizations and are modulated together using a dual-drive Mach-Zehnder modulator to generate a nonreturn-to-zero (NRZ) differentially phase-shift keyed (DPSK) signal.

This is converted into a DQPSK signal by a subsequent all-fiber temperature-stabilized Mach-Zehnder interferometer. Its differential delay τ is about three symbol durations (~ 75 ps), and it has an active phase control by means of a piezo fiber stretcher inserted in one of the arms. Three symbol durations are small enough to keep the differential phase noise tolerable, and large enough to decorrelate the data streams: The absolute value of the cross correlation function is zero at most places and has a maximum equal to 1/4, and in the complex plane there exist transitions between all four DQPSK modulation states of the optical field. At one interferometer output, a 193.8-THz optical band-pass filter (BPF), a 12-GHz photoreceiver, and a subsequent radio frequency (RF) diode detector are used to measure the RF power carried by the optical DQPSK signal. When the two optical DPSK signals are superimposed in quadrature, there is reduced interference and, hence, smallest RF power. A quadrature

Manuscript received November 29, 2004; revised December 18, 2004.

The authors are with Optical Communication and High Frequency Engineering, University Paderborn, Paderborn 33098, Germany (e-mail: suhas@ont.upb.de; sandel@ont.upb.de; milivojevic@ont.upb.de; hidayat@ont.upb.de; fauzi@ont.upb.de; zhang@ont.upb.de; ibrahim@ont.upb.de; wuest@ont.upb.de; noe@upb.de).

Digital Object Identifier 10.1109/LPT.2005.843962

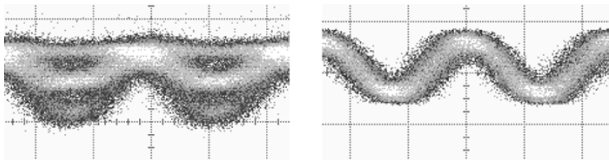

Fig. 2. Back-to-back 40-Gbaud intensity “eye” diagrams of NRZ-DQPSK (left) and RZ-DQPSK signals (right).

control loop based on a 10-kHz lock-in detection scheme stabilizes the interferometer phase by minimizing the RF power. The depth of the 10-kHz phase modulation is only ~ 0.01 rad (root mean square). This stabilization scheme could also be employed in each WDM channel if two parallel Mach–Zehnder modulators were employed for a completely random DQPSK signal generation. If driving voltages have finite transition times and ISI, then both schemes provide cleaner optical signals than a phase modulator cascaded with a Mach–Zehnder modulator [8]. We also tried that latter scheme but could not use it due to ISI.

The laser frequencies are fine-tuned to always the nearest point of a $6.76 \text{ GHz} \approx 1/(2\tau)$ raster so that each WDM channel contains a proper DQPSK signal. The mean channel spacing is roughly an odd multiple of the raster point spacing. This means that each WDM channel has at least one neighbor where in-phase and quadrature data streams are combined with opposite polarities and, hence, form a different optical pattern. After differential interferometric demodulation in the receiver, this means that the in-phase and quadrature data streams are exchanged. In the transmitter, another dual-drive modulator driven at half the clock rate and biased at the transmission minimum carries ~ 13 -ps-long pulses and thereby generates the RZ-DQPSK signal for transmission. Fig. 2 shows “eye” diagrams of the intensity of NRZ and RZ-DQPSK signals at the transmitter. Finally, the DQPSK signal is split, differentially delayed by 112 symbol durations ($\sim 2.8 \text{ ns}$) and recombined with orthogonal polarizations.

The signals are transmitted over 324 km of mixed fiber, in four spans (81.3-km standard single-mode fiber (SSMF); 80-km nonzero dispersion-shifted fiber (NDSF); 41.5-km SSMF + 40-km NDSF; 21.3-km SSMF + 60-km NDSF) with backward-pumped Raman amplification ($\sim 8 \text{ dB}$ in SSMF, $\sim 12 \text{ dB}$ in Truewave RS NDSF). Dispersion compensating modules (DCMs) with dispersions of -683 , -684 , -780 , and -683 ps/nm , respectively, are inserted before the erbium-doped fiber amplifiers (EDFAs) which power the fiber spans. Mean fiber and DCM launch powers per WDM channel are about $-1, \dots, +1 \text{ dBm}$ and $-10, \dots, -5 \text{ dBm}$, respectively. The corresponding EDFA input powers are about $-15, \dots, -10 \text{ dBm}$ per channel.

The optical receiver has an optical preamplifier and a flat top *C*-band DWDM demultiplexer which selects the desired WDM channel between 192.1 and 196.0 THz. Per-channel chromatic dispersion compensation of $-494, \dots, +7 \text{ ps/nm}$ is then applied by means of switchable short pieces of DCF. Linear WDM crosstalk is randomized by the fact that there is a group delay difference, caused by residual chromatic dispersion, of $\sim 10 \text{ ps}$ from channel to channel, and some PMD. It was also tested that a detuning of neighbor and other transmitter frequencies, which

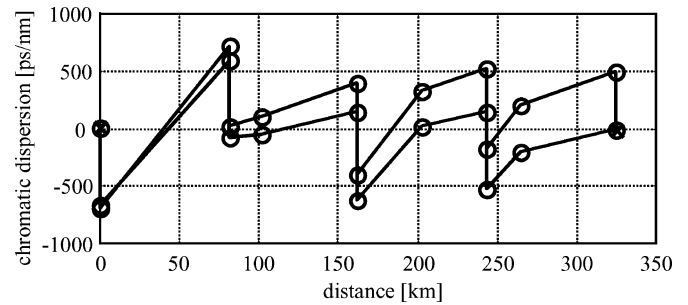

Fig. 3. Accumulated chromatic dispersion at 1530 and 1561 nm versus distance. Connectors are marked by circles, transmit and receive ends by circled x .

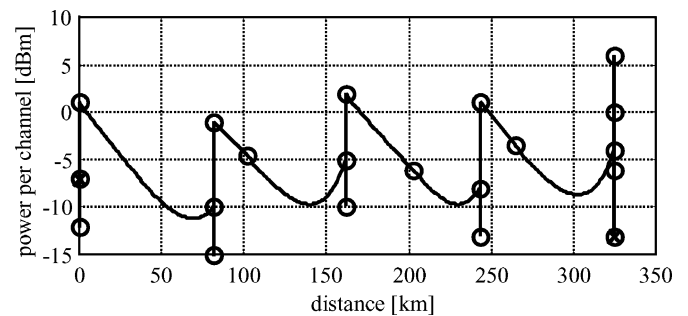

Fig. 4. Power of a typical 160-Gb/s WDM channel versus distance. Connectors are marked by circles, transmit and receive ends by circled x .

completely randomized any existing linear WDM crosstalk because the interferometer phase became random for the interfering channel, did not affect performance.

Fig. 3 show the accumulated chromatic dispersion at the lowest and highest wavelength as a function of distance. Fig. 4 shows the power of a typical channel as a function of distance.

A LiNbO_3 polarization controller transforms the selected WDM signal so that the unwanted polarization is suppressed in a subsequent fiber polarizer. The control strategy is again based on the minimization of the broad-band RF interference noise. Interference occurs when both polarizations are present after the polarizer. This interference noise is detected in another 12-GHz photoreceiver followed by an RF power detector. The measured RF power is -22 dBm in the best case (when the two polarizations are well aligned) and -8.5 dBm in the worst case (when both polarizations pass the polarizer with equal powers). A signal processor automatically minimizes this interference by properly setting the voltages of the LiNbO_3 polarization controller. Speed is not optimized, but the controller is able to track occurring polarization variations of the fiber. There is also a tunable 3-nm optical BPF (not shown) to remove broad-band noise generated in the EDFAs after the WDM demultiplexer.

Another temperature-stabilized all-fiber Mach–Zehnder interferometer, with a delay of one symbol duration, demodulates the signal. For proper reception of in-phase and quadrature data channels, the phase difference of the delay demodulator is set to either 45° or 135° , using a piezo fiber stretcher. The demodulator output fibers are connected to two high-speed photodetectors for balanced detection. Their output signals are fed into the differential inputs of a clock and data recovery with subsequent 1 : 16 demultiplexer. Due to the differential demodulation

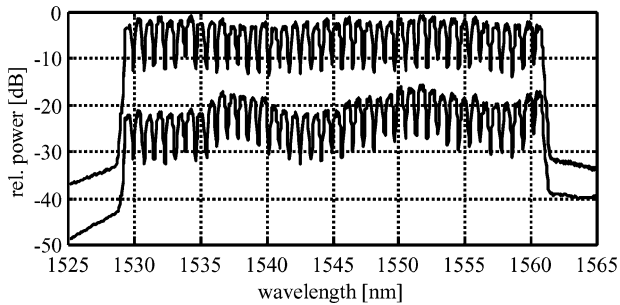

Fig. 5. Optical spectra before (top) and after (bottom) transmission.

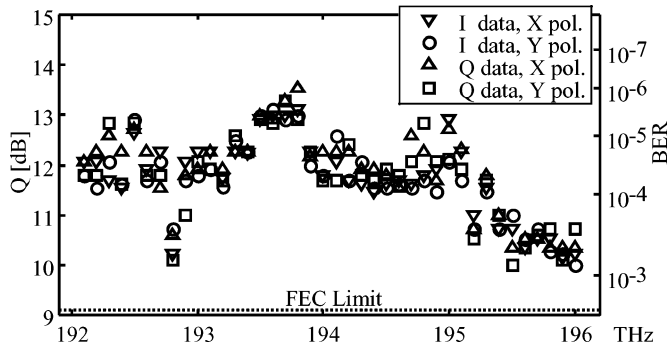

Fig. 6. Measured BERs and corresponding Q -factors, in phase and in quadrature in both polarizations for all 40 channels after 324 km of fiber, as a function of optical frequency.

the recovered bit patterns in the in-phase and quadrature data channels differ from the transmitted ones, which is taken care of by proper programming of the BER tester. The half rate clock signals in transmitter and receiver are generated by voltage controlled oscillators.

III. TRANSMISSION RESULTS

The optical spectra before and after transmission over 324 km of fiber are shown in Fig. 5. Nonuniformities are mostly due to the available (old generation) amplifier material.

Fig. 6 shows measured BERs and corresponding Q -factors, for I and Q data channels in both polarizations. All BER values after transmission were $\leq 8 \cdot 10^{-4}$. They comply with the $2 \cdot 10^{-3}$ limit of an FEC with 7% redundancy [8]. Assuming the presence of such an FEC, the equivalent error-free data rate is 37.1 Gb/s per polarization and quadrature. With 40 WDM channels, the total capacity is therefore 5.94 Tb/s.

Due to a limited laser controller resolution, one of the distributed feedback lasers near 192.8 THz could not be tuned exactly to its DQPSK channel frequency. So there is an extra ~ 1 -dB penalty at this particular channel. The WDM channels ranging from 195.2 to 196.0 also suffer > 1 -dB extra penalty because of insufficient optical amplifier gain at low wavelengths.

The available chromatic dispersion postcompensation stepsize is 2.1 ps/nm. A 1-dB penalty was caused by $\pm(10, \dots, 15)$ ps/nm of uncompensated chromatic dispersion. The WDM laser linewidths ranged between 0.8 and 5.6 MHz, with a mean of 3 MHz. The back-to-back receiver sensitivities were not fully assessed, but ranged between -28 and -32 dBm

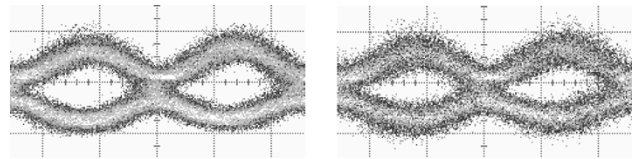

Fig. 7. Interferometrically demodulated eye diagrams at 40 Gb/s before (left) and after transmission (right) in 193.8-THz channel in one polarization and one quadrature.

for a BER of 10^{-3} on 16 tested 160-Gb/s WDM channels, and corresponded to -23 dBm for a BER of 10^{-9} on one (the best) tested channel. Fig. 7 shows exemplary measured eye diagrams of the 193.8-THz channel before and after transmission in one polarization and one quadrature. All quadratures, polarizations, and WDM channels yield very similar eye diagrams.

IV. CONCLUSION

We have transmitted 6.4 Tb/s on 40 160-Gb/s C -band WDM channels above the FEC limit. This corresponds to a 5.94-Tb/s (quasi) error-free transmission under the condition of FEC being present. The line rate is only 40 Gbaud, which is good for dispersion tolerance. Data is sent in two polarizations and differentially encoded in two quadratures per WDM channel. Fiber capacity is thereby quadrupled even though the channel spacing is 100 GHz, which leaves room for further improvement.

REFERENCES

- [1] H. Sotobayashi, W. Chujo, and K. Kitayama, "Highly spectral-efficient optical code-division multiplexing transmission system," *IEEE J. Sel. Topics Quantum Electron.*, vol. 10, no. 2, pp. 250–258, Mar./Apr. 2004.
- [2] N. Yoshikane and I. Morita, "1.14 b/s/Hz spectral efficiency 50×85.4 Gb/s transmission over 300 km using co-polarized CS-RZ DQPSK signals," in *Proc. OFC 2004*, Los Angeles, CA, Postdeadline Paper PDP38.
- [3] S. Bhandare, D. Sandel, A. F. Abas, B. Milivojevic, A. Hidayat, R. Noé, M. Guy, and M. Lapointe, " 2×40 Gbit/s RZ-DQPSK transmission over 263 km of fiber with tunable chromatic dispersion compensator," *Electron. Lett.*, vol. 13, pp. 821–822, Jun. 2004.
- [4] P. S. Cho, G. Harston, C. J. Kerr, A. S. Greenblatt, A. Kaplan, Y. Achiam, G. Levy-Yurista, M. Margalit, Y. Gross, and J. B. Khurgin, "Investigation of 2-b/s/Hz 40 Gbit/s DWDM transmission over 4×100 km SMF-28 fiber using RZ-DQPSK and polarization multiplexing," *IEEE Photon. Technol. Lett.*, vol. 16, no. 2, pp. 656–657, Feb. 2004.
- [5] C. Wree, N. H. Denschlag, E. Gottwald, P. Krummrich, J. Leibrich, E. Schmidt, B. Lankl, and W. Rosenkranz, "High spectral efficiency 1.6-b/s/Hz transmission (8×40 Gb/s with 25-GHz Grid) over 200 km SSMF using RZ-DQPSK and polarization multiplexing," *IEEE Photon. Technol. Lett.*, vol. 15, no. 9, pp. 1303–1305, Sep. 2004.
- [6] A. Fauzi, D. Sandel, A. Hidayat, B. Milivojevic, S. Bhandare, H. Zhang, and R. Noé, " 2.56 Tbit/s, 1.6 bit/s/Hz, 40 Gbaud RZ-DQPSK polarization division multiplex transmission over 273 km of fiber," in *Proc. OECC/COIN 2004*, Yokohama, Japan, Postdeadline Paper PD1-4.
- [7] Y. Zhu, K. Cordina, N. Jolley, R. Feced, H. Kee, R. Rickard, and A. Hadjifotiou, "1.6 bit/s/Hz orthogonally polarized CSRZ-DQPSK transmission of 8×40 Gb/s over 80 km NDSF," in *Proc. OFC 2004*, Los Angeles, CA, Paper TuF1.
- [8] N. Yoshikane and I. Morita, "160% spectrally-efficient 5.12 Tb/s (64×85.4 Gb/s RZ DQPSK) transmission without polarization demultiplexing," in *Proc. ECOC 2004*, Stockholm, Sweden, Paper Th4.4.3.
- [9] J. P. Gordon and L. F. Mollenauer, "Phase noise in photonic communication systems using linear amplifiers," *Opt. Lett.*, vol. 15, pp. 1351–1353, 1990.
- [10] N. Yoshikane and I. Morita, "1.14 b/s/Hz spectrally-efficient 50×85.4 Gb/s transmission over 300 km using copolarized CS-RZ DQPSK signals," in *Proc. OFC 2004*, Los Angeles, CA, Paper PDP38.