

5.94 Tbit/s ($40 \times 2 \times 2 \times 40$ Gbit/s) C-Band Transmission over 324 km using RZ-DQPSK Combined with Polarization Division Multiplex

S. Bhandare, D. Sandel, B. Milivojevic, A. Hidayat, A. Fauzi, H. Zhang, S. K. Ibrahim, F. Wüst, and R. Noé
Univ. Paderborn, EIM-E, Warburger Str. 100, 33098 Paderborn, email: suhas@ont.upb.de; noe@upb.de

Abstract

The combination of RZ-DQPSK with polarization division multiplex, a 16-ary modulation scheme, allows for ultimate spectral efficiency. We raise C band fiber capacity with phase shift keying transmission beyond previously reported figures, achieving FEC limit performance over 4 fiber spans.

1 Introduction

Optical code division multiplex combined with WDM channel polarization alternation allows for a 1.6 bit/s/Hz transmission [1] throughout the whole C band. Other spectrally efficient modulation formats are more chromatic dispersion and PMD tolerant and support larger amplifier spacings. DQPSK transmission [2, 3] can quadruple fiber capacity if it is combined with polarization division multiplex [4–6] or alternating polarizations [7, 8]. An important concern is nonlinear phase noise at high symbol rates [9] but the existence of FEC makes higher raw BERs and hence larger amounts of phase noise tolerable.

Here we increase the C band capacity beyond the 5.12 Tbit/s figure [8], which has recently been reported for DQPSK transmission with alternating polarizations. RZ-DQPSK with polarization division multiplex is chosen because it bears the potential for even a further capacity increase by reducing the channel spacing below 100 GHz, as has been shown for pre-filtered, single-polarization, co-polarized RZ-DQPSK [10].

2 Transmission System

Fig. 1 shows the RZ-DQPSK polarization division multiplex setup for $2 \times 2 \times 40$ Gbit/s transmission per WDM channel, similar to [6]. 2^7-1 PRBS data at 40 Gbit/s is obtained from a 16:1 multiplexer that combines 16 2.5 Gbit/s sub-channels mutually delayed by multiples of 8 bits. The PRBS length is limited by ISI in the electrical multiplexer, an effect which introduces penalties and BER floors also in ASK transmission. The data is impressed onto 40 WDM channels (192.1 ... 196.0 THz) with about 100 GHz channel spacing. They are combined with equal polarizations and are modulated together using a dual-drive Mach-Zehnder modulator to generate an NRZ differentially phase shift keyed (DPSK) signal.

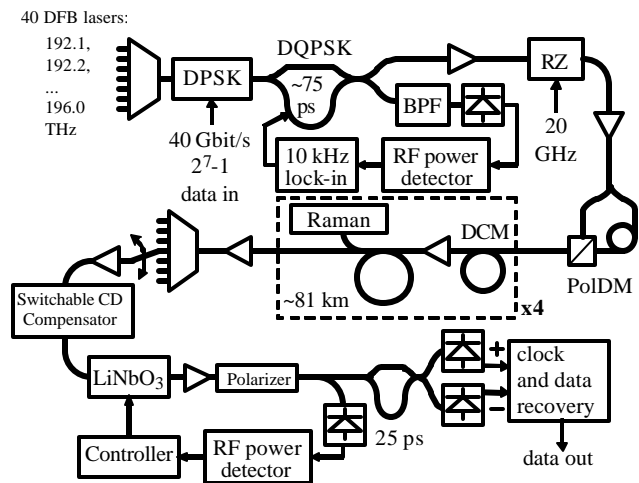

Fig. 1: $40 \times 2 \times 2 \times 40$ Gbit/s RZ-DQPSK polarization division multiplex transmission setup.

This is converted into a differentially quadrature phase shift keyed (DQPSK) signal by a subsequent all-fiber, temperature-stabilized Mach-Zehnder interferometer. Its differential delay τ is about 3 symbol durations (~ 75 ps), and it has an active phase control by means of a piezo fiber stretcher inserted in one of the arms. 3 symbol durations are small enough to keep the differential phase noise tolerable, and large enough to decorrelate the data streams: The absolute value of the cross correlation function is zero at most places and has a maximum equal to 1/4, and in the complex plane there exist transitions between all 4 DQPSK modulation states of the optical field. At one interferometer output, a 193.8 THz optical bandpass filter (BPF), a 12-GHz photoreceiver, and a subsequent RF diode detector are used to measure the RF power carried by the optical DQPSK signal. When the two optical DPSK signals are superimposed in quadrature, there is reduced interference and hence smallest RF power. A quadrature control loop based on a 10 kHz lock-in detection scheme stabilizes the interferometer phase by minimizing the RF power. The depth of the 10 kHz

phase modulation is only ~ 0.01 rad (rms). This stabilization scheme could also be employed in each WDM channel if two parallel Mach-Zehnder modulators were employed for a completely random DQPSK signal generation. If driving voltages have finite transition times and ISI, then both schemes provide cleaner optical signals than a phase modulator cascaded with a Mach-Zehnder modulator [8]. We also tried that latter scheme but could not use it due to ISI. The laser frequencies are always fine-tuned to the nearest point of a $6.76 \text{ GHz} \approx 1/(2\tau)$ raster so that each WDM channel contains a proper DQPSK signal. The mean channel spacing is roughly an odd multiple of the raster point spacing. This means that each WDM channel has at least one neighbor where in-phase and quadrature data streams are combined with opposite polarities and hence form a different optical pattern. After differential interferometric demodulation in the receiver, this means that the in-phase and quadrature data streams are exchanged. In the transmitter, another dual-drive modulator driven at half the clock rate and biased at the transmission minimum carries ~ 13 ps long pulses and thereby generates the RZ-DQPSK signal for transmission. Fig. 2 shows “eye” diagrams of the intensity of NRZ- and RZ-DQPSK signals at the transmitter. Finally, the DQPSK signal is split, differentially delayed by 112 symbol durations (~ 2.8 ns) and recombined with orthogonal polarizations (PoLDM). The signals are transmitted over 324 km of mixed fiber, in 4 spans (81.3 km SSMF; 80 km NDSF; 41.5 km SSMF + 40 km NDSF; 21.3 km SSMF + 60 km NDSF) with backward-pumped Raman amplification (~ 8 dB in SSMF, ~ 12 dB in Truwave RS NDSF). Dispersion compensating modules (DCM) with dispersions of -683 , -684 , -780 , and -683 ps/nm, respectively, are inserted before the EDFAs which power the fiber spans. Mean fiber and DCM launched powers per WDM channel are about $-1 \dots +1$ dBm and $-10 \dots -5$ dBm, respectively. The corresponding EDFA input powers are about -15 dBm $\dots -10$ dBm per channel.

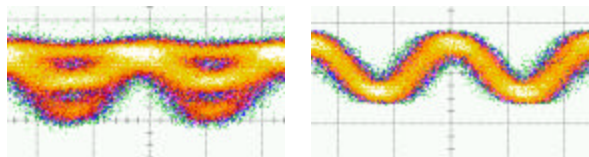

Fig. 2: Back-to-back 40 Gbaud intensity “eye” diagrams of NRZ-DQPSK (left) and RZ-DQPSK signals (right).

The optical receiver has an optical preamplifier and a flat top C band DWDM demultiplexer which selects the desired WDM channel between 192.1 and 196.0 THz.

Per-channel chromatic dispersion compensation of $-494 \dots +7$ ps/nm is then applied by means of switchable short pieces of DCF. Linear WDM crosstalk is randomized by the fact that there is a group delay difference, caused by residual chromatic dispersion, of ~ 10 ps from channel to channel, and some PMD. It was also tested that a detuning of neighbor and other TX frequencies, which completely randomized any existing linear WDM crosstalk because the interferometer phase became random for the interfering channel, did not affect performance.

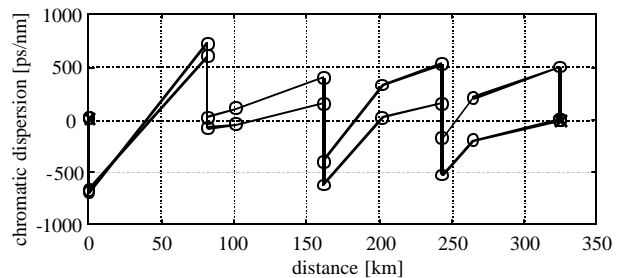

Fig. 3. Accumulated chromatic dispersion at 1530 and 1561 nm vs. distance. Connectors are marked by circles, transmit and receive ends by circled x.

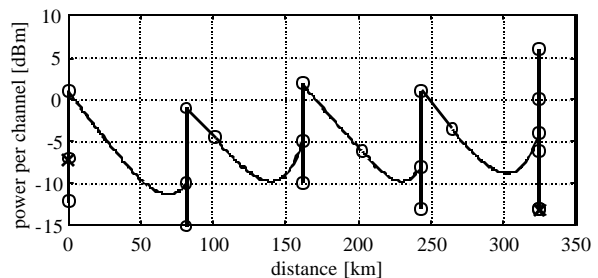

Fig. 4. Power of a typical 160 Gbit/s WDM channel vs. distance. Connectors are marked by circles, transmit and receive ends by circled x.

Fig. 3 show the accumulated chromatic dispersion at the lowest and highest wavelength as a function of distance. Fig. 4 shows the power of a typical channel as a function of distance.

A LiNbO_3 polarization controller transforms the selected WDM signal so that the unwanted polarization is suppressed in a subsequent fiber polarizer. The control strategy is again based on the minimization of the broadband RF interference noise. Interference occurs when both polarizations are present after the polarizer. This interference noise is detected in another 12 GHz photoreceiver followed by an RF power detector. The measured RF power is -22 dBm in the best case (when the two polarizations are well aligned) and -8.5 dBm in the worst case (when both polarizations pass the polarizer with equal powers). A

signal processor automatically minimizes this interference by properly setting the voltages of the LiNbO₃ polarization controller. Speed is not optimized, but the controller is able to track occurring polarization variations of the fiber. There is also a tunable 3-nm optical bandpass filter (not shown) to remove broadband noise generated in the EDFAs after the WDM DEMUX. Another temperature-stabilized, all-fiber Mach-Zehnder interferometer, with a delay of one symbol duration, demodulates the signal. For proper reception of in-phase and quadrature data channels, the phase difference of the delay demodulator is set to either 45° or 135°, using a piezo fiber stretcher. The demodulator output fibers are connected to two high-speed photodetectors for balanced detection. Their output signals are fed into the differential inputs of a clock and data recovery with subsequent 1:16 demultiplexer. Due to the differential demodulation the recovered bit patterns in the in-phase and quadrature data channels differ from the transmitted ones, which is taken care of by proper programming of the BER tester. The half rate clock signals in transmitter and receiver are generated by VCOs.

3 Transmission results

The optical spectra before and after transmission over 324 km of fiber are shown in Fig. 5. Nonuniformities are mostly due to the available (old generation) amplifier material.

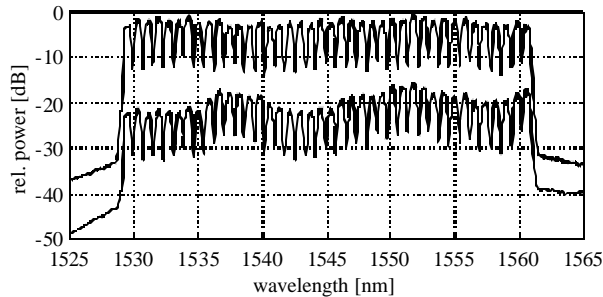

Fig. 5: Optical spectra before (top) and after (bottom) transmission.

Fig. 6 shows measured BERs and corresponding Q factors, for I and Q data channels in both polarizations. All BER values after transmission were $\leq 8 \cdot 10^{-4}$. They comply with the $2 \cdot 10^{-3}$ limit of a FEC with 7% redundancy [8]. Assuming the presence of such a FEC, the equivalent error-free data rate is 37.1 Gbit/s per polarization and quadrature. With 40 WDM channels the total capacity is therefore 5.94 Tbit/s.

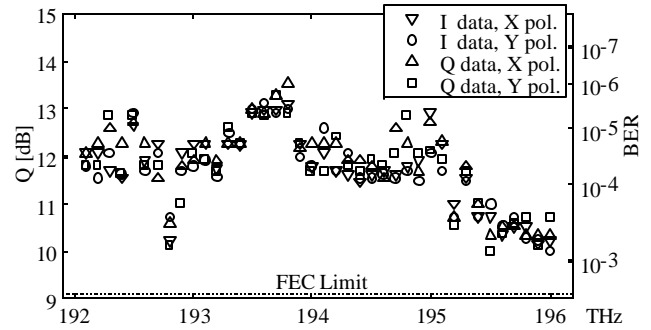

Fig. 6: Measured BERs and corresponding Q factors, in phase and in quadrature in both polarizations for all 40 channels after 324 km of fiber, as a function of optical frequency.

Due to a limited laser controller resolution, one of the DFB lasers near 192.8 THz could not be tuned exactly to its DQPSK channel frequency. So there is an extra ~ 1 dB penalty at this particular channel. The WDM channels ranging from 195.2 to 196.0 also suffer > 1 dB extra penalty because of insufficient optical amplifier gain at shorter wavelengths.

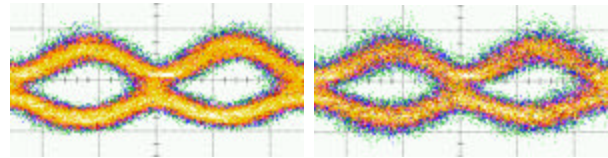

Fig. 7: Interferometrically demodulated eye diagrams at 40 Gbit/s before (left) and after transmission (right) in 193.8 THz channel in one polarization and one quadrature.

The available CD post-compensation stepsize is 2.1 ps/nm. This is sufficient because only 1 dB penalty was experienced when $\pm(10 \dots 15)$ ps/nm of uncompensated chromatic dispersion exist. The WDM laser linewidths ranged between 0.8 and 5.6 MHz, with a mean of 3 MHz. The back-to-back receiver sensitivities were not fully assessed, but ranged between -28 and -32 dBm for a BER of 10^{-3} on 16 tested 160 Gbit/s WDM channels, and corresponded to -23 dBm for a BER of 10^{-9} on one (the best) tested channel. Fig. 7 shows exemplary measured eye diagrams of the 193.8 THz channel before and after transmission in one polarization and one quadrature. All quadratures, polarizations and WDM channels yield very similar eye diagrams.

4 Conclusions

We have transmitted 6.4 Tbit/s on forty 160 Gbit/s C band WDM channels above the FEC limit. This corresponds to a 5.94 Tbit/s (quasi) error-free transmission under the condition of FEC being present. The line rate is only 40 Gbaud, which is good for dispersion tolerance. Data is sent in two polarizations and differentially encoded in two quadratures per WDM channel. Fiber capacity is thereby quadrupled even though the channel spacing is 100 GHz, which leaves room for further improvement.

5 References

- [1] H. Sotobayashi, W. Chujo, and K. Kitayama, "Highly spectral-efficient optical code-division multiplexing transmission system", *IEEE J. Selected Topics in Quantum Electron.*, vol. 10, pp. 250-258, 2004.
- [2] N. Yoshikane and I. Morita, "1.14 b/s/Hz spectral efficiency 50 x 85.4 Gb/s transmission over 300 km using co-polarized CS-RZ DQPSK signals", in *Proc. OFC2 004*, Postdeadline Paper PDP38.
- [3] S. Bhandare, D. Sandel, A. F. Abas, B. Milivojevic, A. Hidayat, R. Noé, M. Guy, M. Lapointe, "2x40 Gbit/s RZ-DQPSK transmission over 263 km of fiber with tunable chromatic dispersion compensator", *IEEE Electron. Lett.* vol. 13, pp. 821-822, June 2004.
- [4] P. S. Cho, G. Harston, C. J. Kerr, A. S. Greenblatt, A. Kaplan, Y. Achiam, G. Levy-Yurista, M. Margalit, Y. Gross, and J. B. Khurgin, "Investigation of 2-b/s/Hz 40 Gbit/s DWDM Transmission Over 4 x 100 km SMF-28 Fiber Using RZ-DQPSK and Polarization Multiplexing", *IEEE Photon. Technol. Lett.*, vol. 16, pp. 656-657, Feb. 2004.
- [5] C. Wree, N. H. Denschlag, E. Gottwald, P. Krummrich, J. Leibrich, E. Schmidt, B. Lankl, and W. Rosenkranz, "High Spectral Efficiency 1.6-b/s/Hz Transmission (8 x 40 Gb/s With 25-GHz Grid) Over 200km SSMF Using RZ-DQPSK and polarization multiplexing", *IEEE Photon. Technol. Lett.*, vol. 15, pp. 1303-1305, Sept. 2004.
- [6] A. Fauzi, D. Sandel, A. Hidayat, B. Milivojevic, S. Bhandare, H. Zhang, and R. Noé, "2.56 Tbit/s, 1.6 bit/s/Hz, 40 Gbaud RZ-DQPSK polarization division multiplex transmission over 273 km of fiber", in *Proc. OECC/COIN 2004*, Yokohama, Japan, Postdeadline Paper PD1-4.
- [7] Y. Zhu, K. Cordina, N. Jolley, R. Feced, H. Kee, R. Rickard, A. Hadjifotiou, "1.6 bit/s/Hz orthogonally polarized CSRZ-DQPSK transmission of 8x40 Gb/s over 80 km NDSF", *Proc. OFC 2004*, TuF1
- [8] N. Yoshikane, I. Morita, "160 % Spectrally-Efficient 5.12 Tb/s (64 x 85.4 Gb/s RZ DQPSK) Transmission without Polarization Demultiplexing", in *Proc. ECOC 2004*, Paper Th4.4.3.
- [9] J.P. Gordon, L.F. Mollenauer, "Phase noise in photonic communication systems using linear amplifiers", *Optics Lett.* **15**, (1990), pp. 1351-1353